

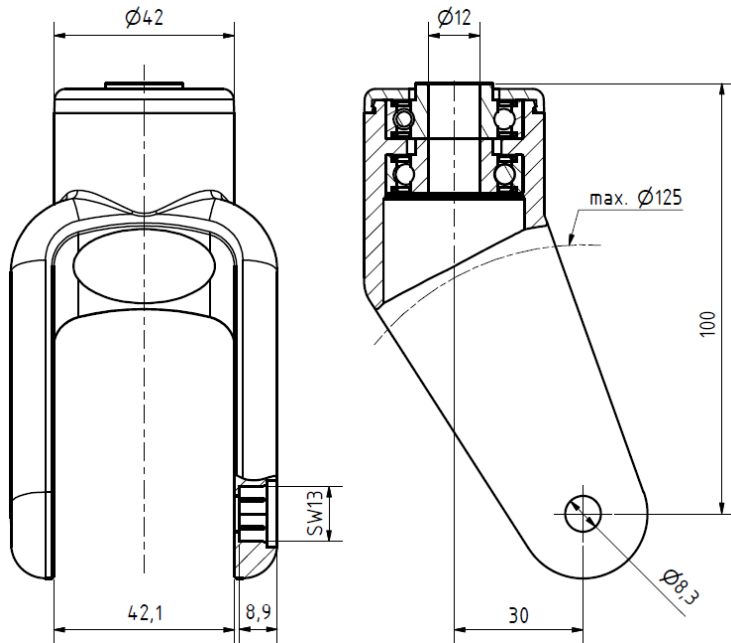



LG-125-42-12



Art. No.	 Max. wheel diameter	 Bore	 Hub length	 Axial dimension
LG-125/42/12	125 mm	12 mm	42 mm	8 mm

Optional accessories:

- Cylinder head screw ISO 4762 galvanised M8X55
- Hexagonal nut, self-locking DIN 985 galvanised M8

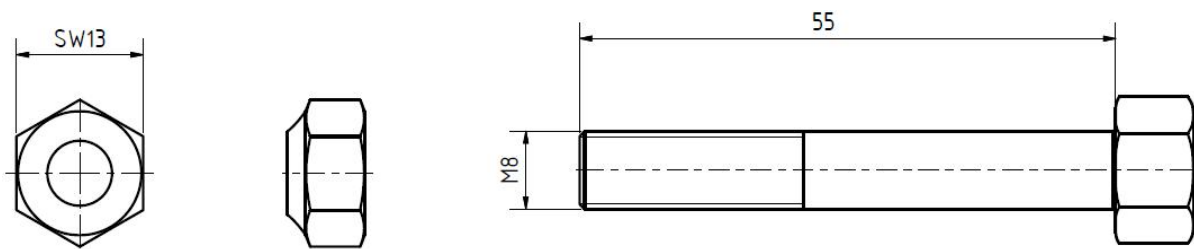

Typical assembly:



for wheel
X0305-125/150/30